





















Update: 01/2024

 ACCIAIO INOX AISI 316L STAINLESS STEEL AISI 316L EDELSTAHL AISI 316L		 15-108
 Germany	  **	
 France	 	
 Austria	 *	
 Norway	  *	
 Sweden		
 Netherlands		
 Switzerland		
 Denmark	  *	
 Russia		
 Italy	 	
 Czech Rep.	 * 	
 Australia	  *	
 Poland	   *	
 USA		

 ACCIAIO INOX GAS AISI 316L STAINLESS STEEL GAS AISI 316L EDELSTAHL GAS AISI 316L	
 Germany	
 Austria	 *

 ACCIAIO AL CARBONIO CARBON STEEL C-STAHL	
 Germany	 **
 France	 *
 Sweden	
 Czech Rep.	 * 
 Poland	  *
 Australia	 *

* Omologazione ottenuta direttamente dal distributore.

Approval obtained directly by our distributor.

Inhaber der Zulassung ist unser Vertreter.

** Gamma omologata **VdS** da Ø22 a Ø108 mm, valida esclusivamente per l'utilizzo abbinato di tubi e raccordi Eurotubi Europa.

VdS approved range from Ø22 to Ø108 mm, valid only for the combined use of Eurotubi Europa pipes and fittings.

VdS zugelassen von Ø22 - 108 mm, gilt ausschliesslich bei Verwendung von Eurotubi Fittings kombiniert mit Eurotubi Europa Rohren.

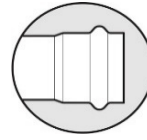

RISE

Adattatore tee - filetto femmina

T-piece with female thread

T-Stück mit I.G.

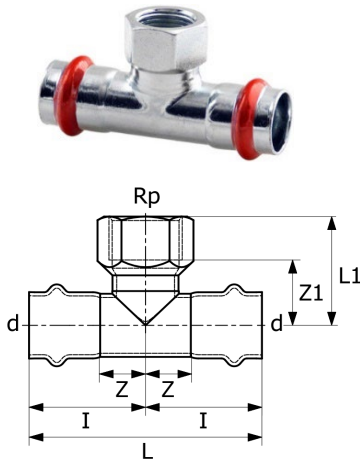

Code	d - Rp - d	L	L1	Z	Z1	I			MOQ
C42NBVI-LBP	12-Rp ^{3/8} -12	64	34	14	24	32	64	20	100
C42PBVI-LBP	12-Rp ^{1/2} -12	64	37	14	25	32	70	20	100
C42PCVI-LBP	15-Rp ^{1/2} -15	74	37	16	25	37	89	20	160
C42PDVI-LBP	18-Rp ^{1/2} -18	76	39	17	27	38	98	20	120
C42PEVI-LBP	22-Rp ^{1/2} -22	85	37	20	25	43	132	20	200
C42QEVI-LBP	22-Rp ^{3/4} -22	85	41	20	28	43	136	20	100
C42PFVI-LBP	28-Rp ^{1/2} -28	90	41	21	29	45	158	10	200
C42QFVI-LBP	28-Rp ^{3/4} -28	90	45	21	32	45	162	10	100
C42PGVI-LBP	35-Rp ^{1/2} -35	106	43	26	31	53	201	10	100
C42QGV-LBP	35-Rp ^{3/4} -35	106	47	26	34	53	205	10	40
C42PHVI-LBP	42-Rp ^{1/2} -42	127	47	31	35	63	269	5	60
C42QHVI-LBP	42-Rp ^{3/4} -42	127	51	31	38	63	273	5	40
C42PJVI-LBP	54-Rp ^{1/2} -54	141	54	34	42	71	357	6	42
C42QJVI-LBP	54-Rp ^{3/4} -54	141	58	34	45	71	361	6	36

Tee allargato

T-piece enlarged

T-Stück mit vergr. Abgang

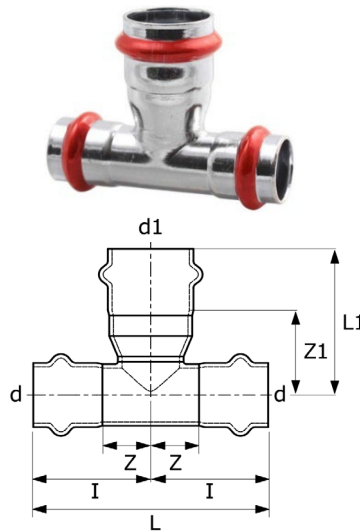

Code	d - d1 - d	L	L1	Z	Z1	I			MOQ
C44CBVI-LBP	12-15-12	64	45	14	24	32	56	20	100
C44DCVI-LBP	15-18-15	74	47	16	26	37	78	20	100
C44ECVI-LBP	15-22-15	74	50	16	27	37	88	20	100
C44EDVI-LBP	18-22-18	76	52	17	29	38	96	20	80
C44FEVI-LBP	22-28-22	85	57	20	33	43	130	10	80

Girella con dado in ottone e guarnizione piatta in EPDM

Adaptor with union nut in brass and EPDM flat seal

Anschlussverschraubung mit EPDM-Flachdichtung und Messingmutter

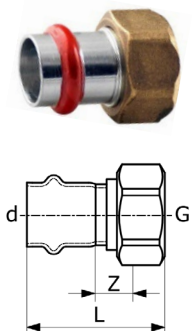

Code	d - G (ISO 228)	L	Z			MOQ
C60QCVI-LBP	15-G ^{3/4}	42	14	82	10	100
C60QDVI-LBP	18-G ^{3/4}	42	14	83	10	100
C60REVI-LBP	22-G1	45	13	117	10	60
C60SFVI-LBP	28-G1 ^{1/4}	50	16	194	10	50
C60TGVI-LBP	35-G1 ^{1/2}	52	14	289	8	40
C60UHVI-LBP	42-G1 ^{3/4}	63	19	361	4	20
C60WJVI-LBP	54-G2 ^{3/8}	69	19	545	4	12